

3-FUNCTION HAND SHOWER WITH PAUSE FEATURE

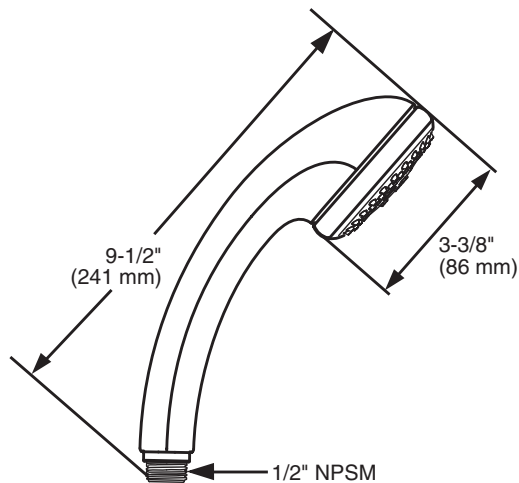

MODEL NUMBER:

- **1660.766** 3-Function Hand Shower with Pause Feature - 1.5 gpm (5.7 L/min.)
- **1660.767** 3-Function Hand Shower with Pause Feature - 2.5 gpm (9.5 L/min.)



GENERAL DESCRIPTION:

Hand shower has pause feature on handle to provide a non-positive shut-off that reduces the flow to a trickle. 3-Function hand shower adjusts from full spray to a combination to a massage. Easy clean rubber spray nozzles. Includes pressure compensating flow regulator and check valve. Hand showers available in 2 versions (1.5 gpm/5.7 L/min and 2.5 gpm/9.5 L/min. maximum flow rate.

PRODUCT FEATURES:

Pause Feature: Non-positive shut-off button on handle reduces flow to a trickle to meet ADA requirement

Water Saving: 1.5 gpm version saves up to 40% in water usage

Pressure Compensating Flow Control Device: Provides consistent flow over a wide pressure range

Easy Clean Spray Nozzles: Allows for easy cleaning of lime and calcium build up. Rubber nozzles will not clog

SUGGESTED SPECIFICATION

Hand shower shall include a non-positive shut-off to be ADA compliant. Shall also include a permanent built-in pressure compensating control device to provide consistent flow over a wide pressure range. A check valve to prevent back flow. Fitting shall be American Standard Model # 1660.76_._._._.

CODES AND STANDARDS

These products meet or exceed the following codes and standards:

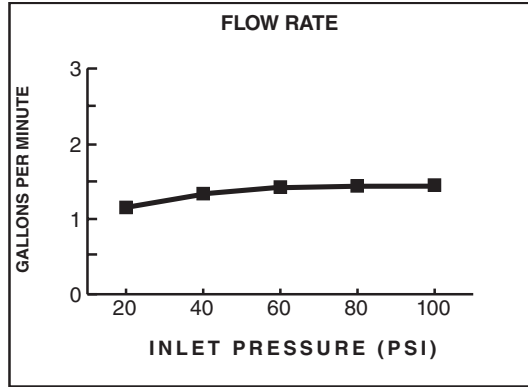

- ASME A112.18.1**
- CSA B125.1**
- ANSI A117.1**



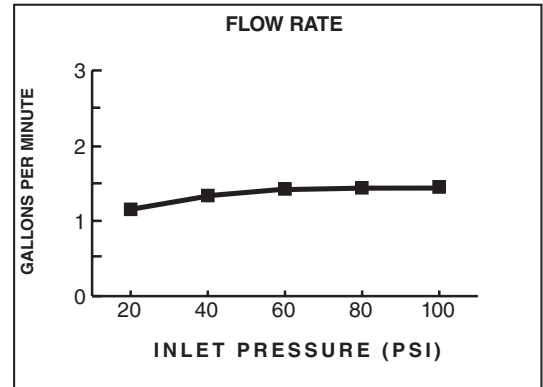



1660.766 - 1.5 gpm (5.7 L/min.)





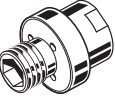

1660.767 - 2.5 gpm (9.5 L/min.)

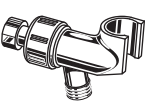
Product Number	Description	Finish Options	
		Polished Chrome 002	PVD Satin Nickel 295
1660.766	3-Function Hand Shower with Pause Feature, 1.5 gpm	 	
1660.767	3-Function Hand Shower with Pause Feature, 2.5 gpm		

 Meets the American Disabilities Act Guidelines and ANSI A117.1 Requirements for the physically challenged.

Hand Shower Accessories	
Product Number	Description
8888.035	59" Metal Shower Hose 
8888.053	79" Metal Shower Hose (Chrome Only) 
1660.400	Vacuum Breaker 
1660.410	Shower Arm Diverter 
8888.096	Shower Arm Bracket 

Hand Shower Accessories	
Product Number	Description
8888.036	Fixed Wall Bracket 
8888.037	Wall Supply 
8888.068	Round Wall Supply 
8888.069	Square Wall Supply 
8888.038	Wall Supply Bracket 